

**7 ?**

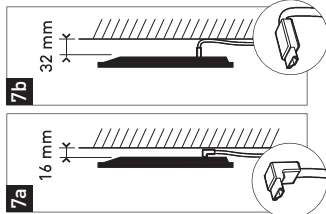

**7a**



16 mm

**7b**



32 mm

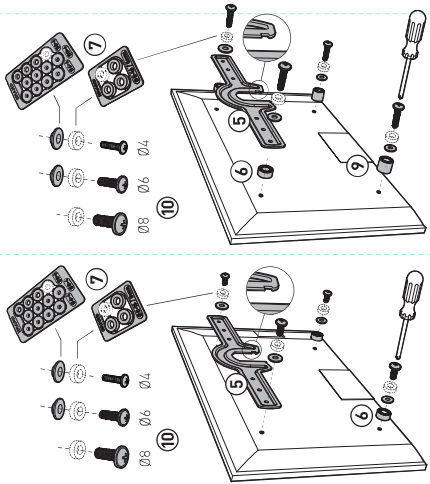

**8**

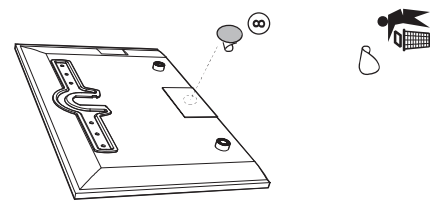

**9**

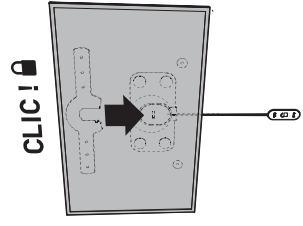

**10**

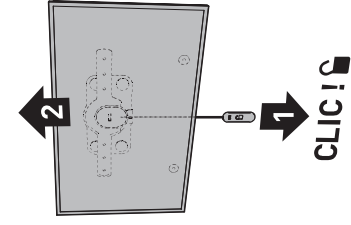

**11**

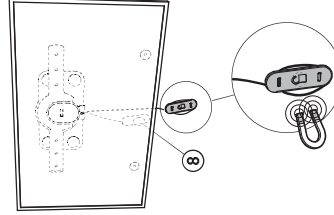

**FIXIT 400**

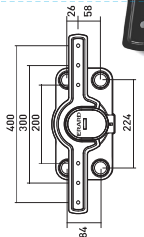

REF : 044040

SUPPORT MURAL ULTRA-FIN POUR ECRAIN PLAT  
ULTRA FLAT WALL MOUNT FOR FLAT TV-SCREEN  
V2.2

**L**  
30-65"  
76-165 cm

**60 KG**  
TESTE JUSQU'A 240 KG  
TESTE JUSQU'À 240 KG



**ERARD®**

Vous avez des questions ?  
Vous avez besoin de conseils ?  
N° Vert **0 800 40 40 60**  
international : +33 472 46 16 26

Fabrique en France  
Made in France  
[www.erard.com](http://www.erard.com)

51102-2-2-24-2-2015

**1**

15 mm (Ø4,6/8)  
25 mm (Ø4,6/8)  
35 mm (Ø4,8)  
45 mm (Ø8)  
20 mm (Ø4,6/8)  
30 mm (Ø4,6/8)  
40 mm (Ø4,8)  
50 mm (Ø8)

**2**

**3** ?

**3a**

**3b**

**3a**

Ø8

x4

**3b**

x4

**4**

**5**

**6**

**7**